

USPAS 2015: East Brunswick, Rutgers

**Collective Effects,
Instabilities,
Higher Order Modes**

Christoph Steier

Lawrence Berkeley National Laboratory

Outline

- Motivation
- Instabilities
 - Single Bunch
 - Multi Bunch
 - Two Stream
- Feedback Systems

Introduction

- Instabilities are coherent processes leading to usually exponential amplitude growth
 - Coherent means that an ensemble of particles is involved (either bunch, many bunches, cw beam, ...)
 - This is different from single particle effects like the interaction of individual beam particles with external fields (magnets, cavities)
- Very important topic for any high current accelerator, storage ring, ...
- Classification according to
 - Single bunch – Multibunch
 - Longitudinal – Transverse
 - Impedance type: Narrow Band – Broadband
 - Higher modes in cavities, resonant structures – resistive wall, step transitions, tapers, ...
 - Shape of oscillation: Dipole, Quadrupole, ...

Image Charges/Vacuum Chamber

- In the lab system the beam electromagnetic field of a relativistic particle is transversely confined within an angle of $\sim 1/\gamma$.
- For the Maxwell equations, the electric field associated with the particle beam, must terminate perpendicularly on the chamber equipotential conductive walls – Image Charges

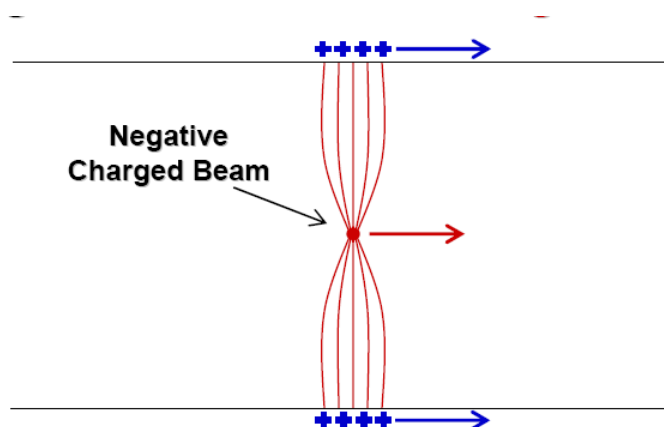
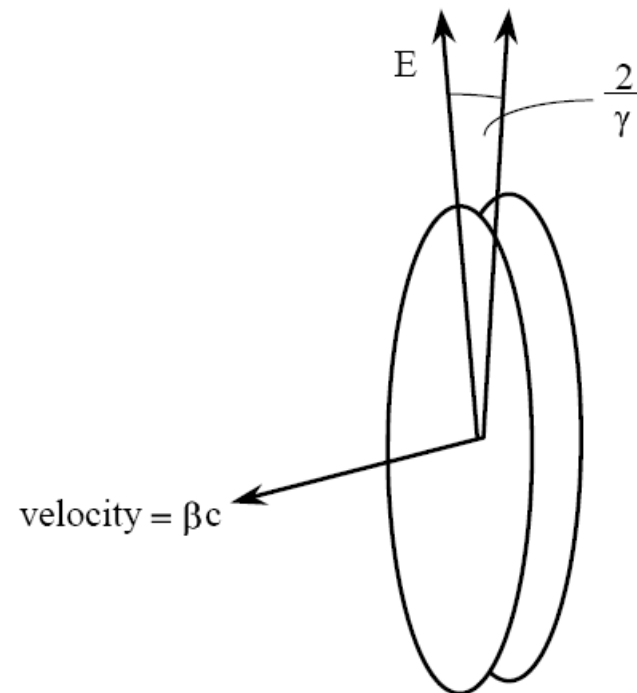

Wake Fields and Instabilities

- Wake fields are transient effects, they are generated during a bunch passage and last for a finite amount of time that depends on the particular wake and on the geometry of the vacuum chamber.
- If the wake field lasts for the duration of a bunch (order of 10-100 ps), particles in the bunch tail can interact with the wakes generated by the particles in the head
 - Single bunch instabilities can be triggered (distortion of the longitudinal distribution, bunch lengthening, ...).

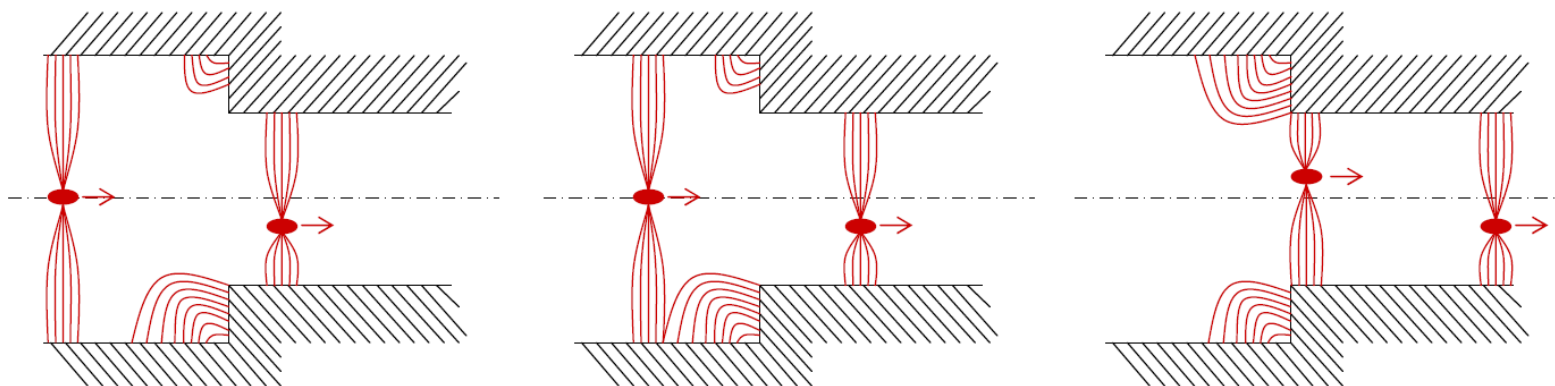

- If the wake field lasts longer, for example for the time between bunches (several ns), wakes from leading bunches can interact with following bunches and potentially generate multi-bunch or coupled bunch instabilities.

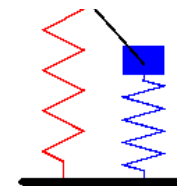

Impedance

- The wake function represents the interaction of the beam with the external environment in *time domain*.
- As in other cases (e.g. resonant electrical circuits), the equivalent *frequency domain* analysis can be very useful as well. The frequency domain equivalent of the wake function is the impedance, measured in Ohm and defined as the *Fourier transform of the wake function*:

$$Z(\vec{r}, \vec{r}_{trail}, \omega) = \int_{-\infty}^{\infty} W(\vec{r}, \vec{r}_{trail}, \tau) e^{-j\omega\tau} d\tau \quad \text{with } \tau = t_{trail} - t$$

- If I is the Fourier transform of the charge distribution, the Fourier transform of the total induced voltage is simply given by:

$$\tilde{V}(\vec{r}, \vec{r}_{trail}, \omega) = Z(\vec{r}, \vec{r}_{trail}, \omega) I(\vec{r}, \omega)$$

- And the time domain expression can be obtained by the inverse Fourier transform:

$$V(\vec{r}, \vec{r}_{trail}, \tau) = \frac{1}{2\pi} \int_{-\infty}^{\infty} \tilde{V}(\vec{r}, \vec{r}_{trail}, \omega) e^{j\omega\tau} d\omega$$

Impedance Interpretation

- The impedance has real and imaginary parts:

$$Z(\vec{r}, \vec{r}_{trail}, \omega) = Z_R(\vec{r}, \vec{r}_{trail}, \omega) + j Z_j(\vec{r}, \vec{r}_{trail}, \omega)$$

- There is an analogy between wake field and electronic circuit theories. This can be used to represent wakes by equivalent circuits.
- The resistive part of the coupling impedance is responsible for the beam energy losses, while the imaginary part defines the phase relation between the beam excitation and the wake potential.
- For example, the impedance of a parallel RLC circuit is often associated to the impedance of the so-called *higher order modes* (HOM), single resonance wakes in the vacuum chamber.

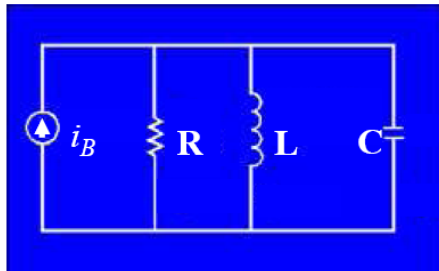

$$Z(\omega) = \frac{R}{1 + jQ \left(\frac{\omega}{\omega_R} - \frac{\omega_R}{\omega} \right)}, \quad \omega_R = \frac{1}{\sqrt{LC}}, \quad Q = R \sqrt{\frac{C}{L}}$$

$$W(\tau) = \begin{cases} 0 & \tau < 0 \\ \frac{e^{-\omega_R \tau / 2Q}}{C} \left[\cos\left(\omega_R \tau \sqrt{1 - 1/4Q^2}\right) - \frac{\sin\left(\omega_R \tau \sqrt{1 - 1/4Q^2}\right)}{\sqrt{4Q^2 - 1}} \right] & \tau > 0 \end{cases}$$

ALS Narrow- and Broad-Band Impedances

- Using the RLC model HOMs can be classified in two main categories:
 - Narrow-band impedances.
 - Relatively high Q , *i.e.* spectrum is narrow.
 - Wakes last for a relatively long time
 - Important for multibunch instabilities.

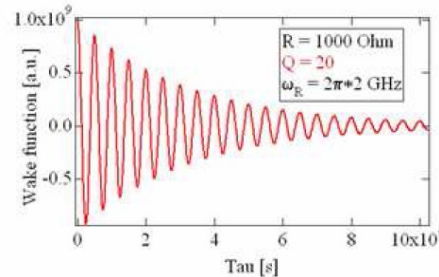
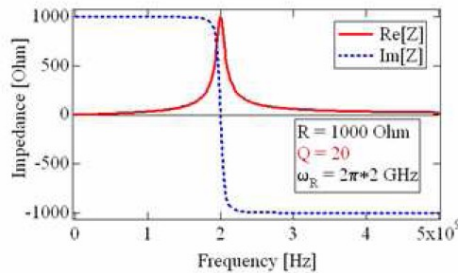

- Low Q , *i.e.* spectrum is broader.
- Wakes last for a relatively short time
- Important only for single bunch instabilities.

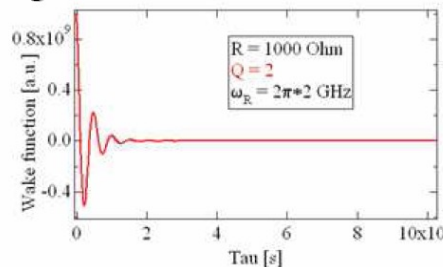
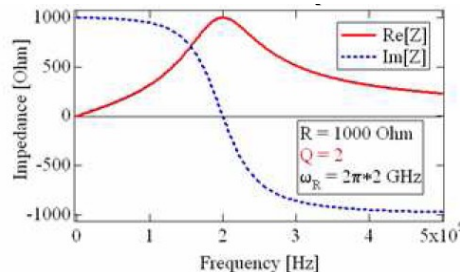

Sidebands in frequency spectrum

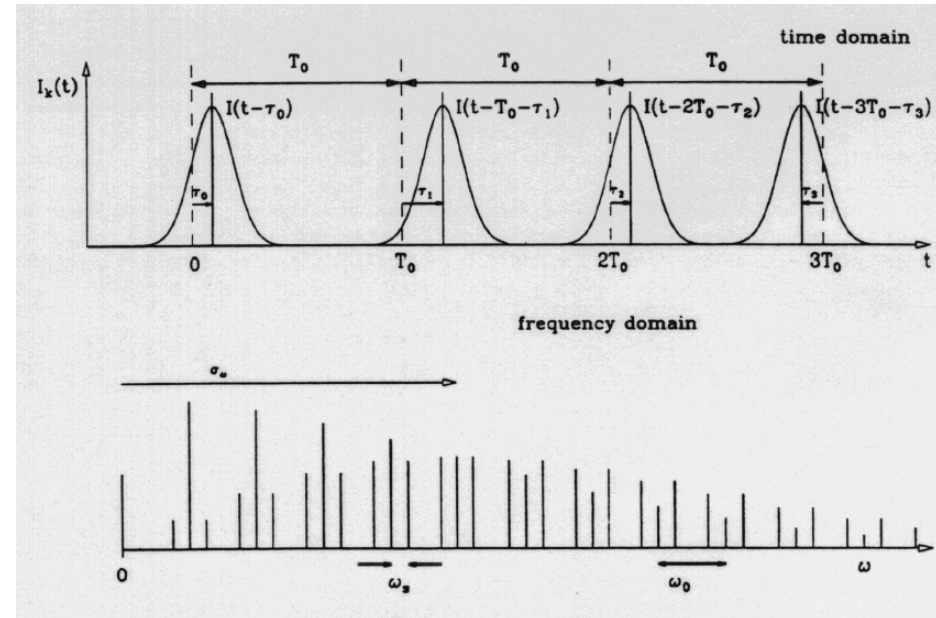
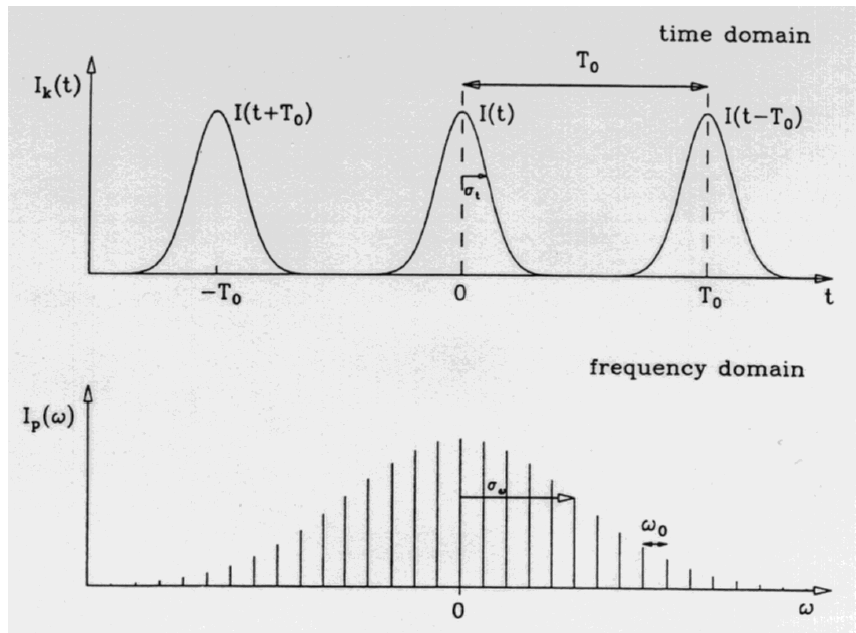

- Oscillations of the bunches show up as additional spectral lines (sidebands)
 - Synchrotron oscillations (Energy – Phase/Arrival Time) on sum signal
 - Betatron oscillations (transverse position – angle) on difference signal
- Separation from revolution harmonics is fractional synchrotron tune or betatron tune

Driving Force - Impedance

- In case of instabilities, driving 'force' is normally an induced 'force' such as voltage induced by passage of the charged beam itself.
- Since force is induced by the beam, it can only have components at frequencies corresponding to the modes of oscillation of the beam itself.
- Thus the force results from the spectrum of the beam oscillation 'sampling' the impedance Z seen by the beam.

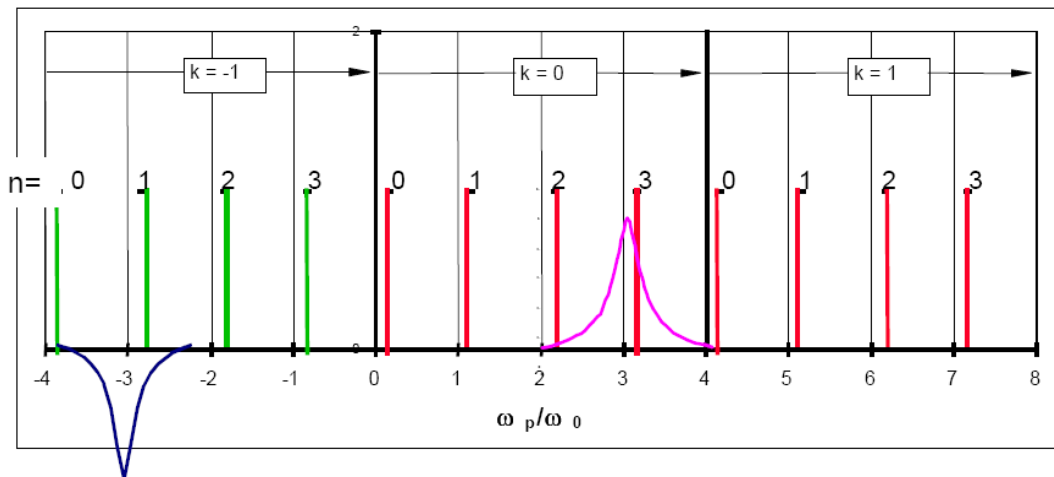

Examples of instabilities (excited sidebands)

- Specific sidebands being excited correspond to specific instability characteristics:
 - Mode number, dipole/quadrupole/...
 - Frequency of the HOM driving the instability (modulo RF frequency)

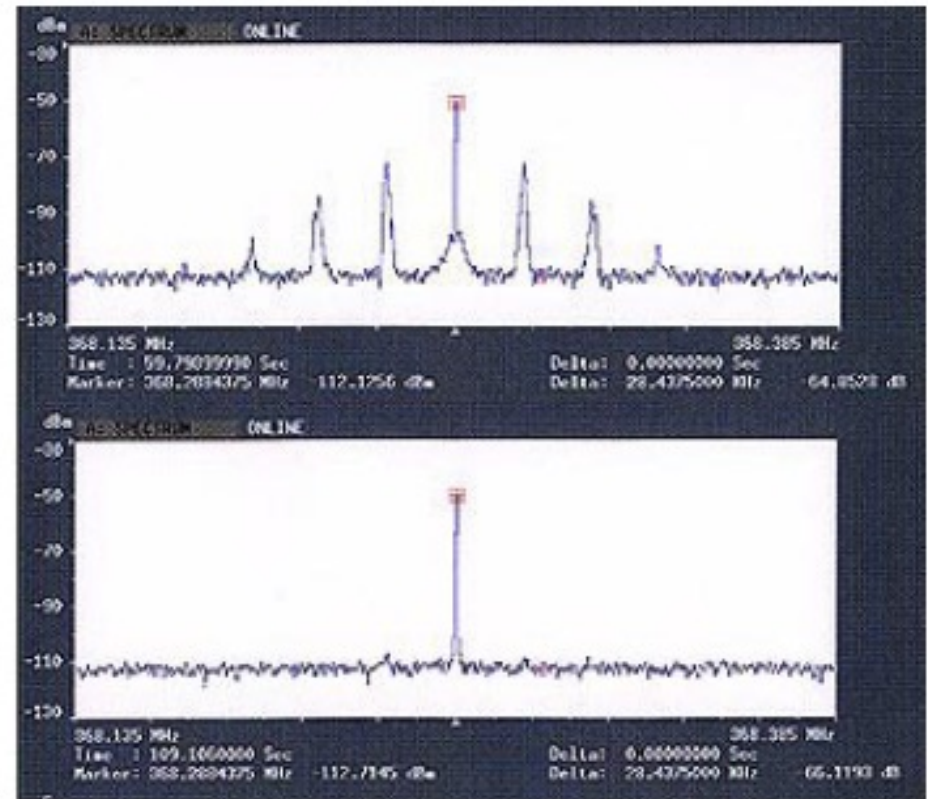
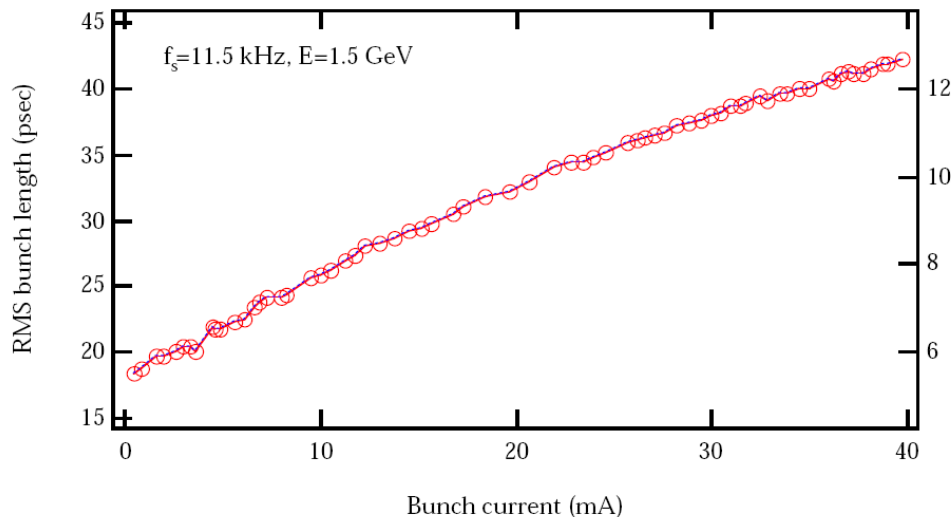
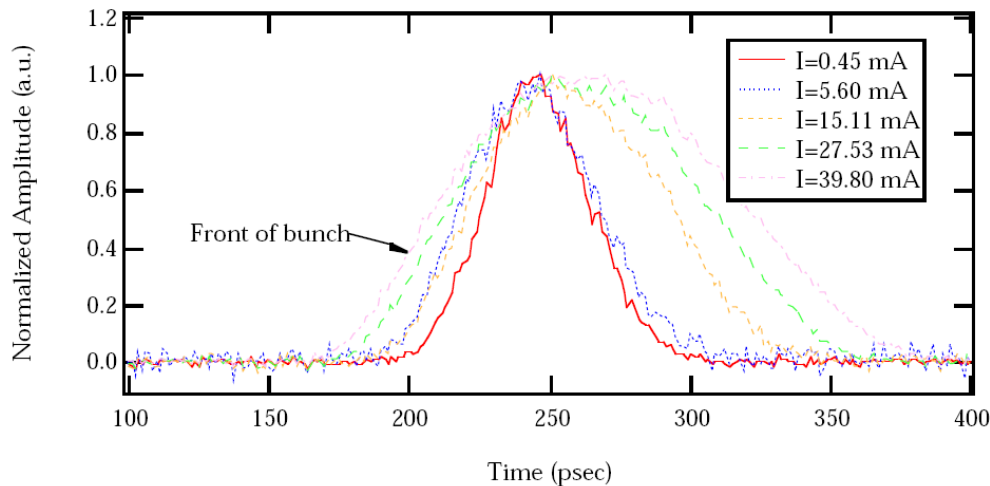

Figure 3: Longitudinal pick-up signal spectrum of 30 bunches with feedback off - feedback on.

Single Bunch Effects

- Broadband impedances have important effects on accelerators.
- In electron storage rings in the presence of radiation damping, the equilibrium distributions at low current are usually gaussian. By increasing the current per bunch, the wakes become stronger and one can generate non gaussian equilibrium distributions.
- In LINACS and in heavy ion accelerators, broad band impedances can generate emittance and energy spread growth.
- In all accelerators, if the current per bunch is increased further, the wakes can become strong enough to generate single bunch instabilities that can severely change the characteristics of the bunch and/or generate particle losses.
- In what follows, some examples will be given.

Potential Well Distortion



Potential well distortion causes current dependent bunch lengthening (as well as shape distortion and phase shift)

- Effect is unavoidable, but its magnitude depends on impedance

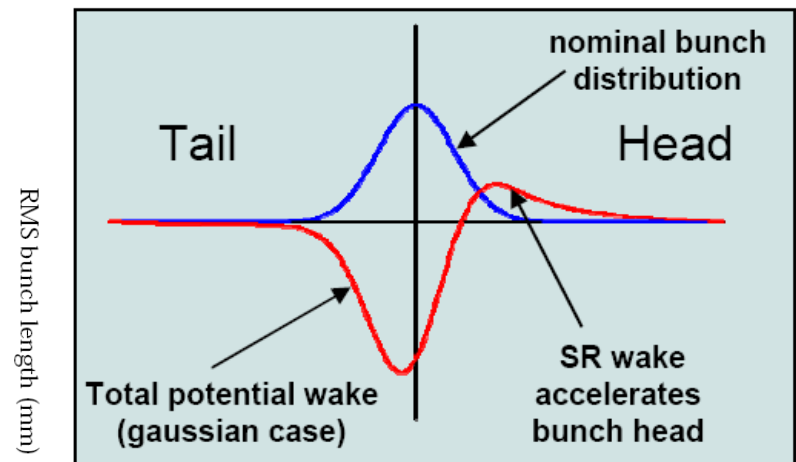

How to Measure Bunch Length

- There are several ways to measure bunch length
 - Use emitted synchrotron radiation
 - Streak camera
 - Nonlinear crystal ...
 - Interact laser with bunches
 - Measure frequency spectrum

Principle of streak camera

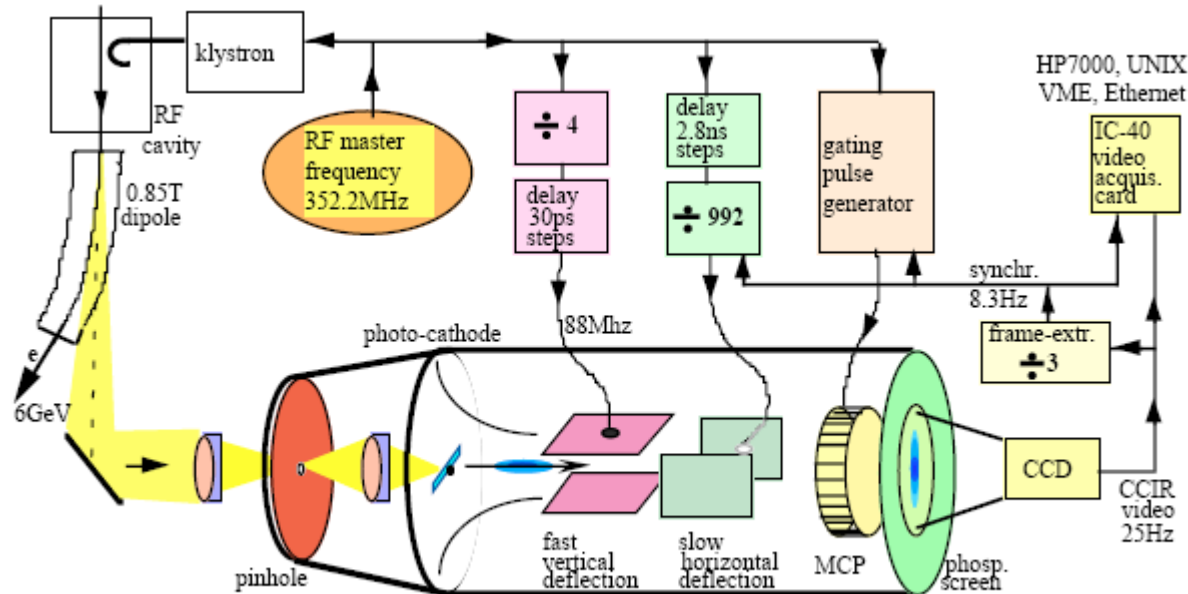
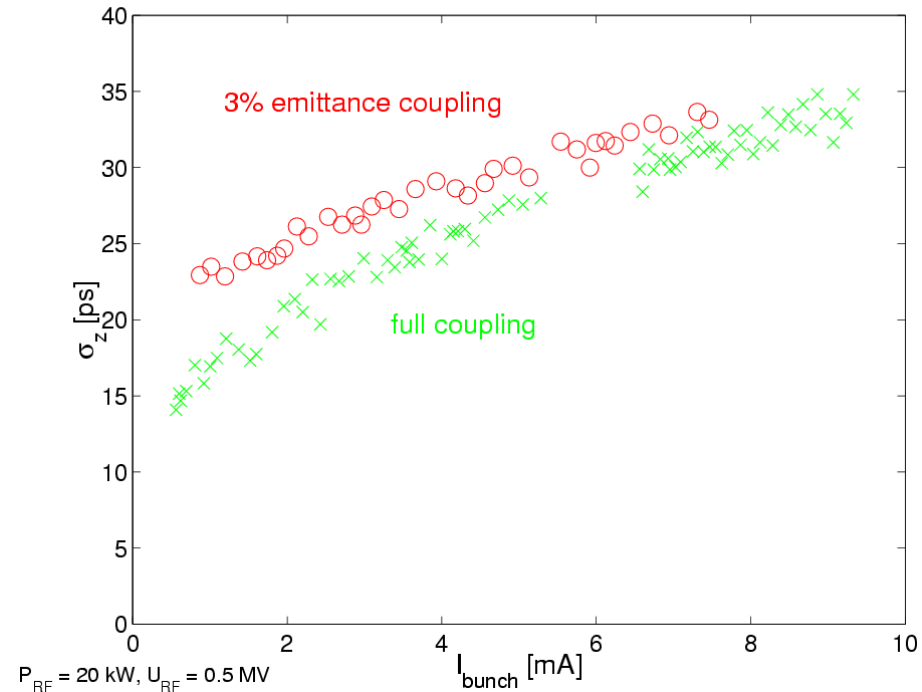

Figure: 1 Synchronisation of the Streak Camera system

- Convert light signal into electron beam (photo cathode)
- Accelerate electrons
- Use fast deflection to translate time delay into position difference
- In many ways similar to CRT ...

ALS Other example application of bunch length measurements

- Streak cameras allow
 - slow measurements (average bunch length over time or vs current)
 - picture on the right shows bunch length as a function of current at 1.0 GeV in the ALS, particularly the effect of intra beams cattering (IBS)
 - Fast measurements (bunch-by-bunch and turn-by-turn)



Bunch spectrum

Using a spectrum analyzer with a BPM can yield a wealth of information on beam optics and stability. A single bunch with charge q in a storage ring with a revolution time T_{rev} gives the following signal on an oscilloscope

$$I(t) = \sum_{n=-\infty}^{\infty} q \delta(t - nT_{\text{rev}}),$$

where I'm assuming a zero-length bunch. A spectrum analyzer would see the Fourier transform of this,

$$I(\omega) = \sum_{n=-\infty}^{\infty} q \omega_{\text{rev}} \delta(\omega - n\omega_{\text{rev}})$$

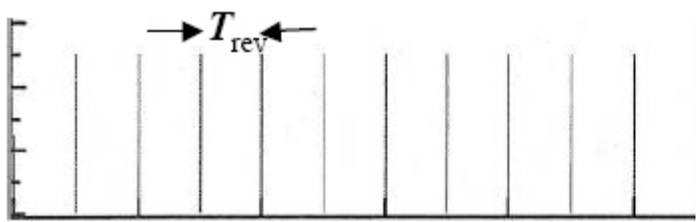

Time

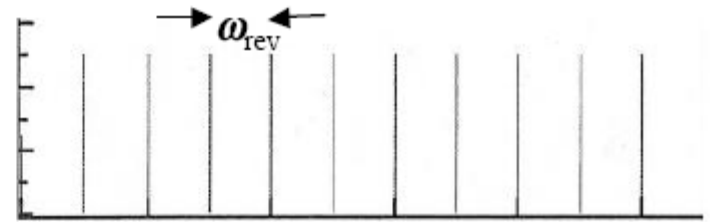

Frequency

ALS Dependence of Spectrum on Bunch Length

For finite bunch length, the single bunch spectrum rolls off as the Fourier transform of the longitudinal bunch profile (Gaussian for e-rings).

Courtesy J. Byrd

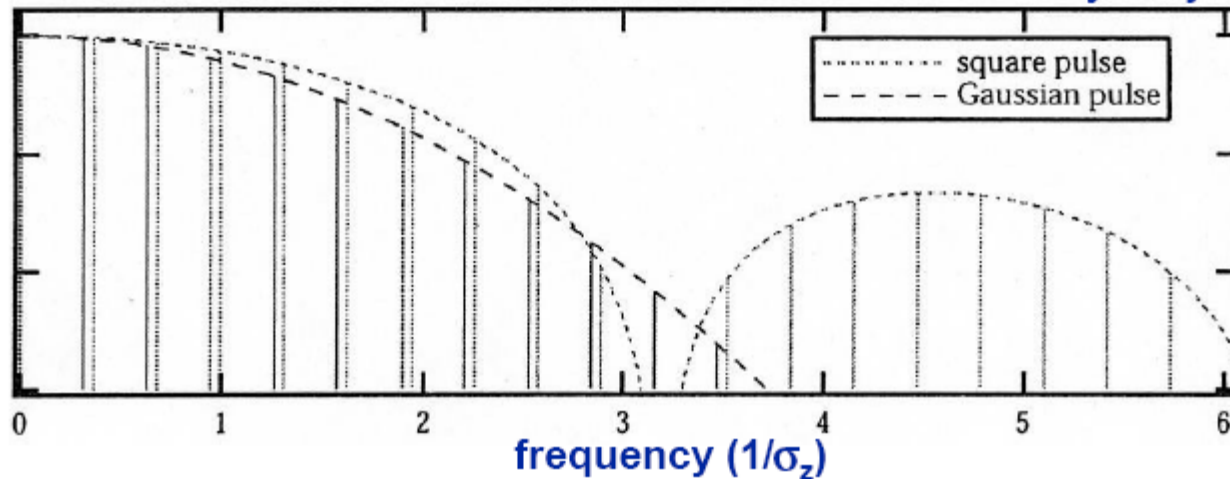

For SPEAR3 $\sigma_z = 4.5$ mm, so $c/\sigma_z = 67$ GHz.

Microwave Instability

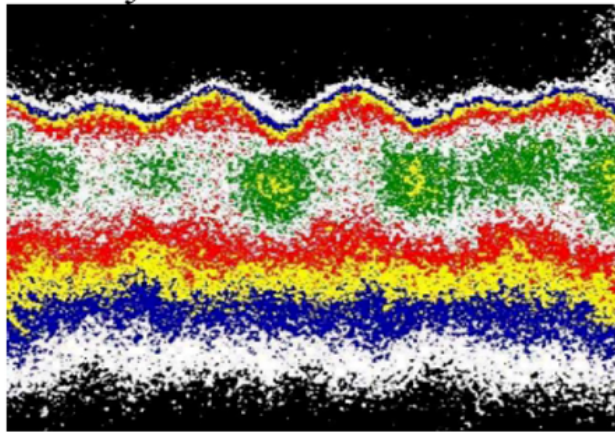

Streak camera image of bunch length vs. time at low momentum compaction factor in ESRF

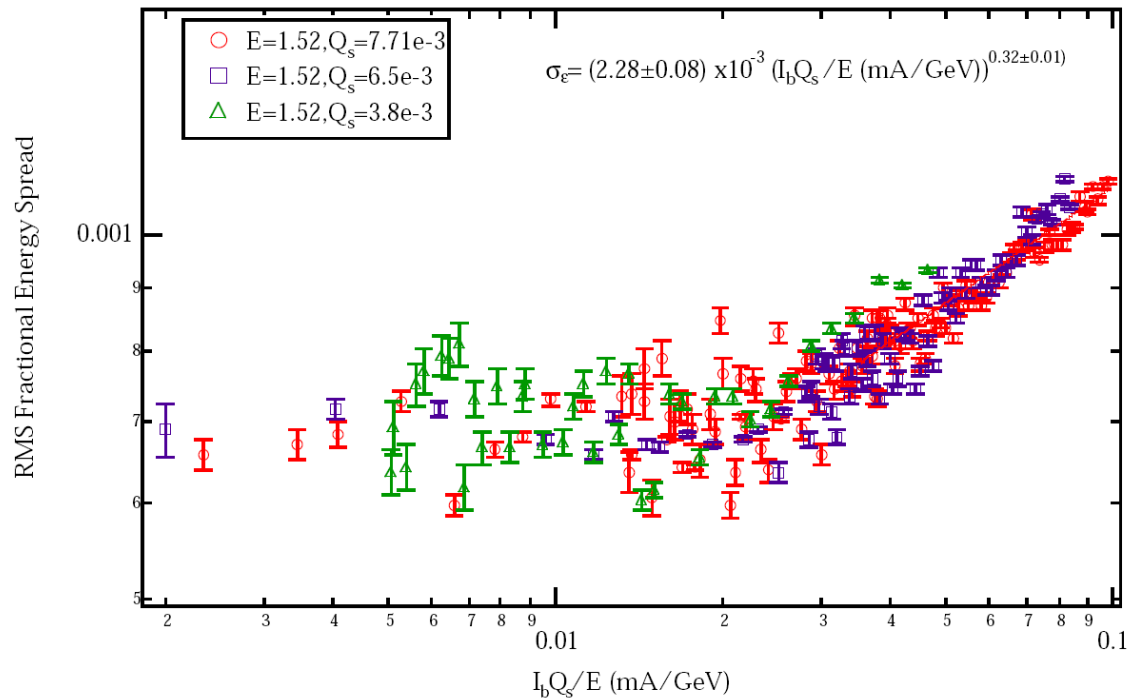

$$\sigma_\epsilon^3 = \frac{1}{\sqrt{2\pi}\alpha^2} \left(\frac{I_b Q_s}{(E/e)} \right) \left[\left| \frac{Z_{//}}{n} \right| + \text{Im} \frac{Z_{//}}{n} \right]$$

$$Z/n = 0.08 \Omega$$

ALS Tunes shift vs. single bunch current

Measured vertical tune shift vs bunch current since beginning of ALS operations

$$\frac{dQ}{dI} = \frac{R}{4\sqrt{\pi}(E/e)\sigma_v} \beta Z_{eff}$$

$$Z_{eff,vert} = 250 \text{ k}\Omega$$

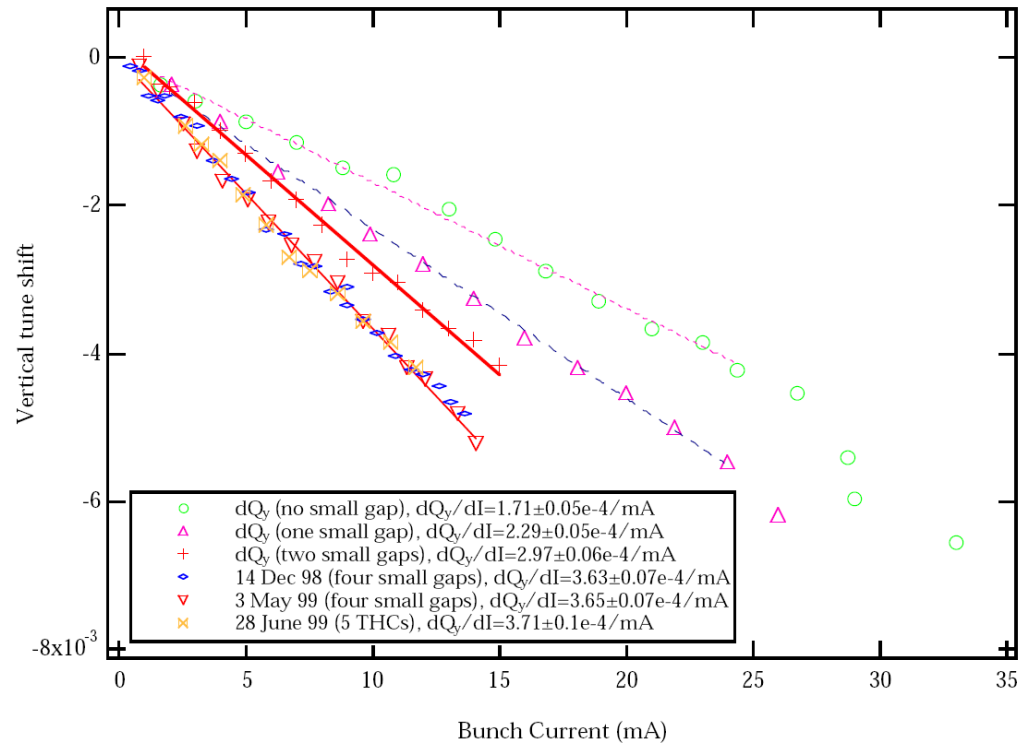

- Depends on number and shape/size of small gap undulator vacuum chambers for most light sources

- If the transverse tunes shift with current gets large enough a mixed transverse-longitudinal instability can occur
- Betatron and synchrotron oscillation modes couple together
- Happens approx. when the first two head-tail modes cross, i.e. the transverse tune is shifted by about one synchrotron tune

Picture: Streak Camera
Images of Head-Tail
Instabilities in ESRF, LEP

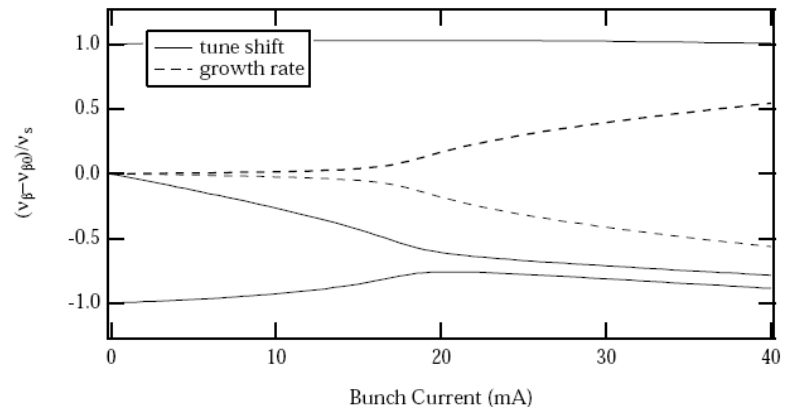
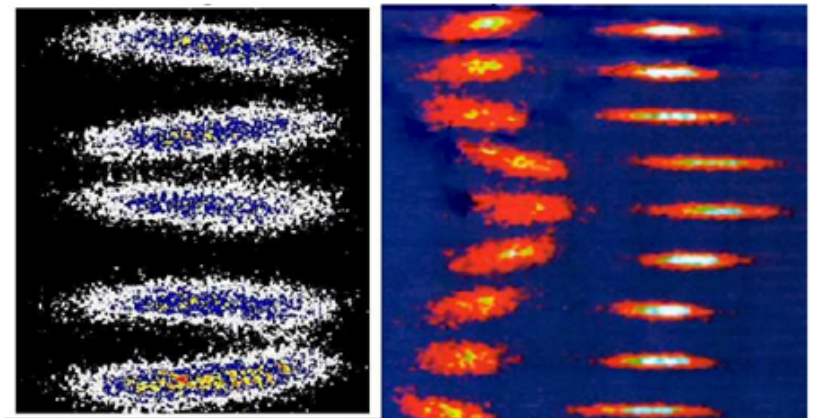
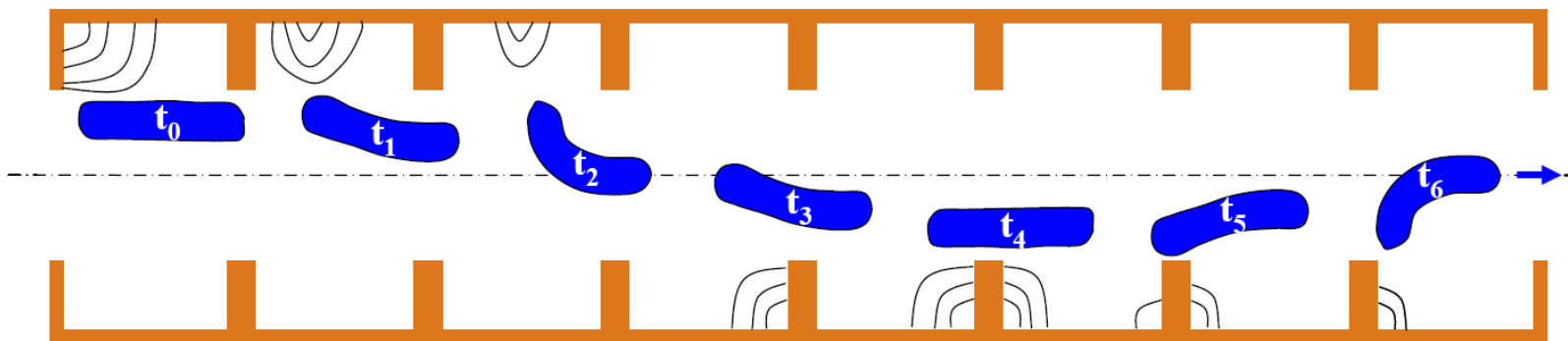

Figure 1: Example calculation of mode coupling instability using the MOSES code. The solid lines show the tune shift of the $m=0, \pm 1$ modes. The dashed lines show the growth (and damping) rates of the coupled modes above threshold.



Beam Breakup

- When a bunch enters off-axis in a linac structure it excites transverse wakes.
- If the impedance associated with the wake is broad-band, the head of the bunch can excite wakes that will deflect the tail of the bunch.
- In long high current/bunch linacs the effect can build up and the bunch can be distorted into a “banana” like shape. This effect is known as single-bunch beam break up (SBBU).



- The effect was first observed in 1966 at SLAC in the 2 miles long linac and was one of the luminosity limitations of the SLC (Stanford Linear Collider).

Multibunch Instabilities

- In the case of narrow-band impedances the wake generated by one bunch can last long enough to interfere with other bunches or with the bunch itself in subsequent turns. In this situation multi-bunch instabilities can be excited.
- High current accelerators are carefully designed in order to minimize broad band and narrow band impedances. However, even in the best accelerator, the impedance is nonzero and there will always be a current threshold above which the beam will become unstable.
- If the accelerator is required to operate above the instability threshold, *active feedback systems* are necessary for damping down the instabilities.
- Properly designed accelerators with low overall broad-band impedance, carefully damped HOMs and active longitudinal and transverse bunch by bunch feedbacks can store large numbers of particles. Currents of several Amperes have been stored in electron and positron machines (PEP 2, KEK-B, DAFNE, ...) and of many tens of mA in proton machines (SPS, TEVATRON, HERA, ...).

ALS Multi Bunch Instabilities: Mode Number

- Depending on the frequency of the driving impedance, instabilities with different mode number, i.e. different phase shift from one bunch to the next are driven.
- Example for dipole oscillations of 4 bunches:

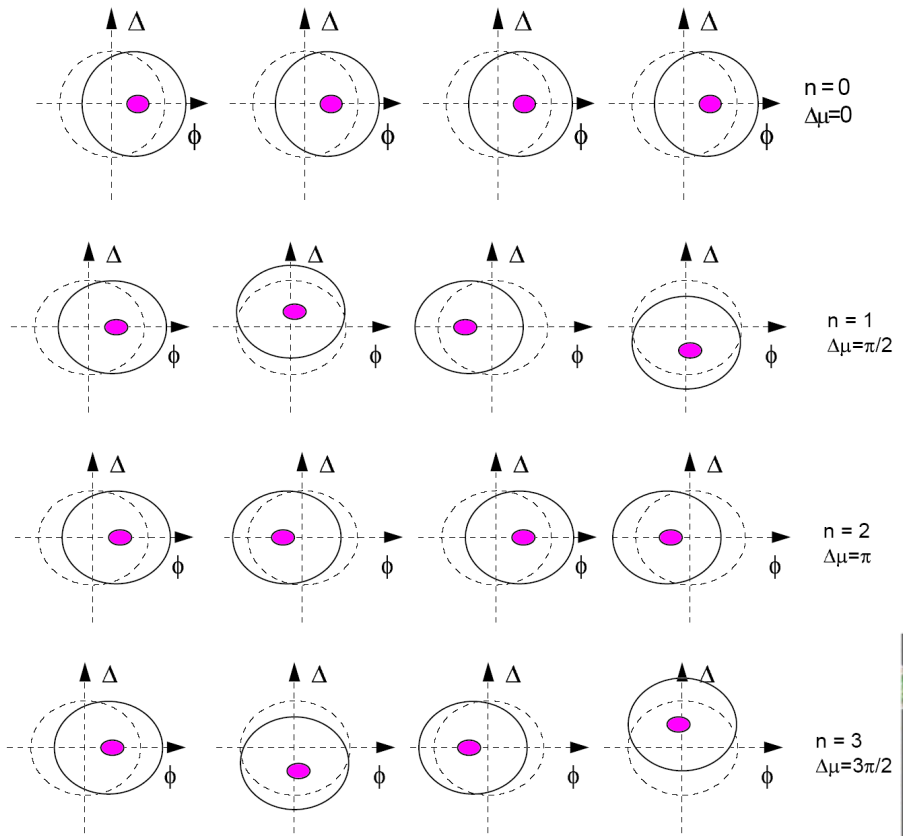

Streak camera image of HOM driven, longitudinal multibunch instability at ESRF

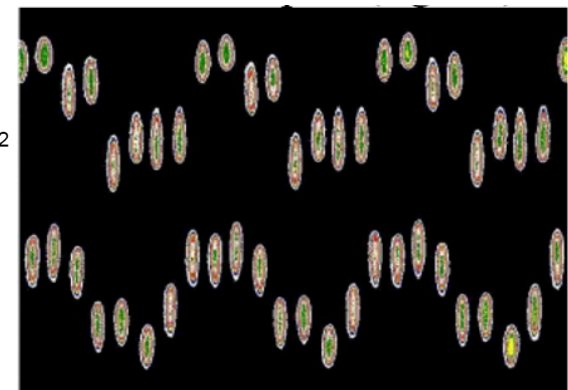

Feedback Systems

- Detect bunch offset (transverse) or bunch phase/arrival time (longitudinal)
- Do detection with high bandwidth
- Amplify signal by large factor (low noise)
- Feed back with 90 degree phase shift (kick instead of offset)

Feedback systems (practical)

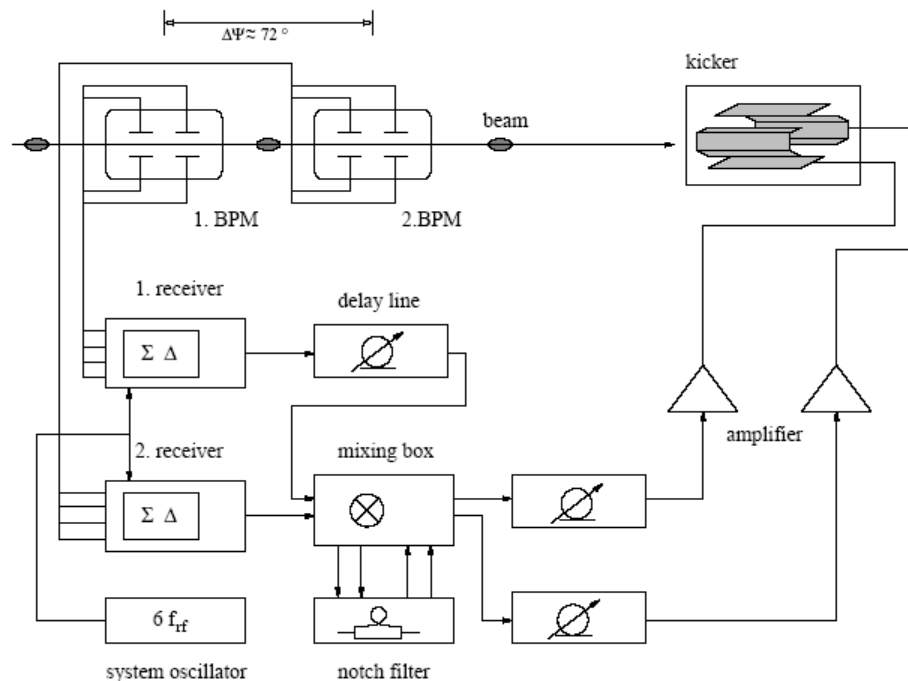
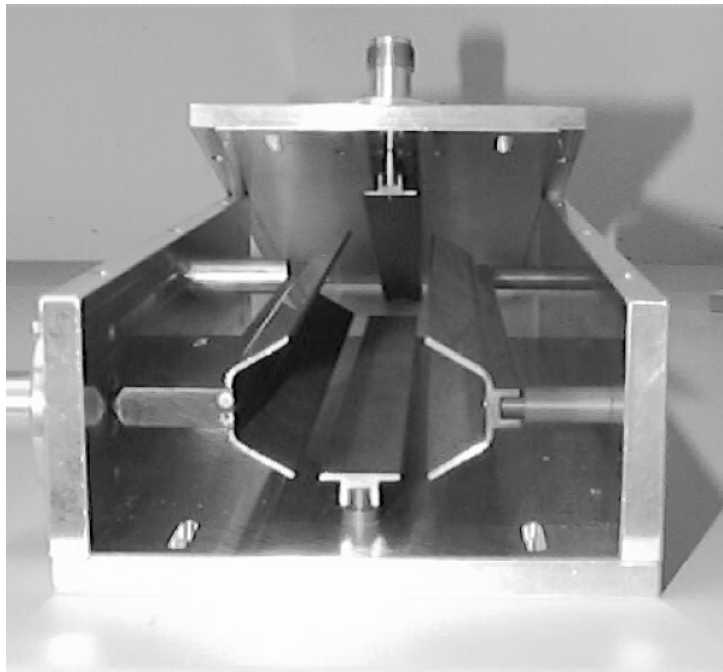

- Stripline kicker (uses electrical and magnetic field) – broadband
- Signal processing electronics includes delays, mixers, amplifiers
- Notch filter to suppress DC response (and response at revolution harmonics)

ALS Coupled bunch instability diagnostics

a) Osc. Envelopes in Time Domain

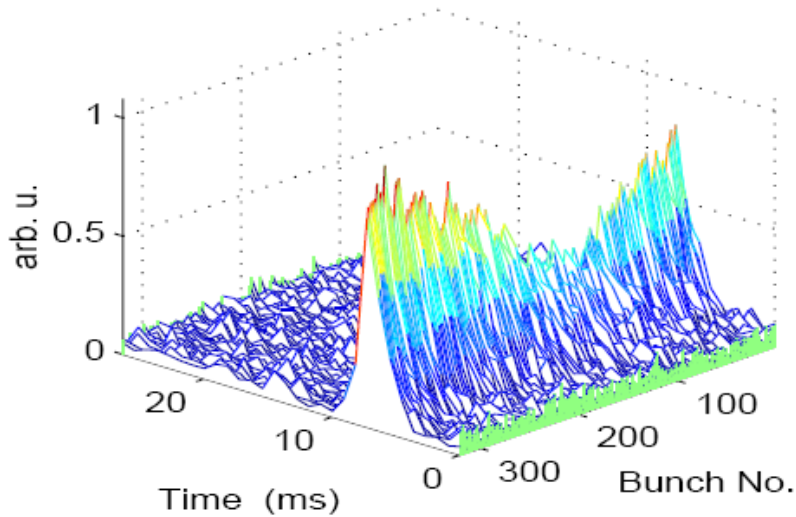

Figure 1: . Grow-Damp sequence in the horizontal plane from the ALS. The envelope of the bunch motion shows the free growth ($0 < t < 6\text{ms}$), then damping under the action of feedback ($t > 6\text{ms}$)

b) Evolution of Modes

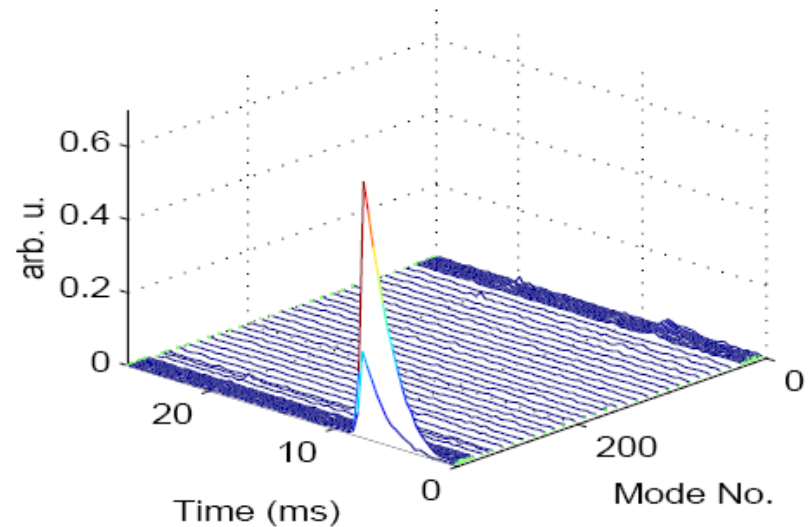

Figure 2: . The recorded bunch motion is Fourier transformed to reveal the growth of modes 326 and 327.

- Grow-damp measurements with feedback systems allow quantitative study of instabilities (and feedback performance)
 - Growth Rate
 - Damping Rate
 - Mode Pattern

More diagnostics: Cavity Temperature Scans

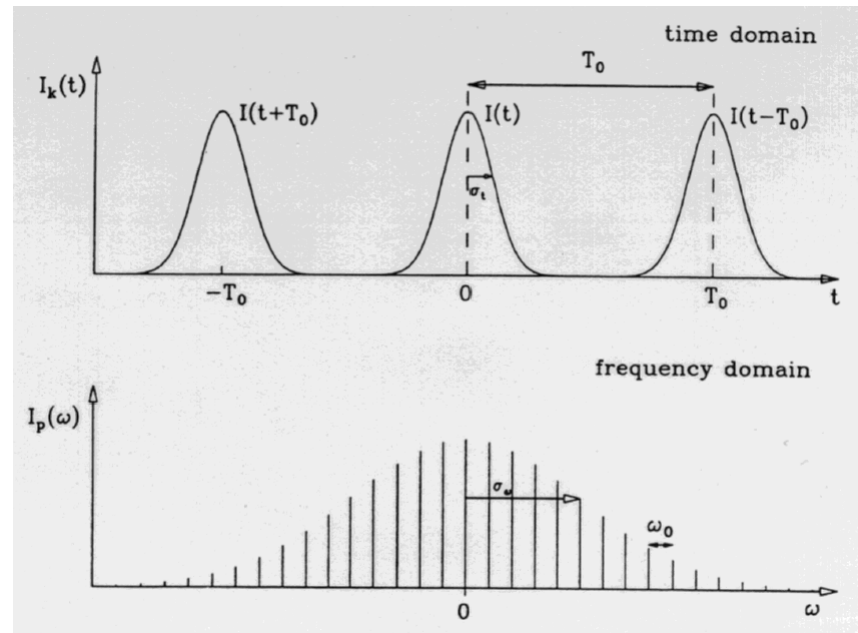
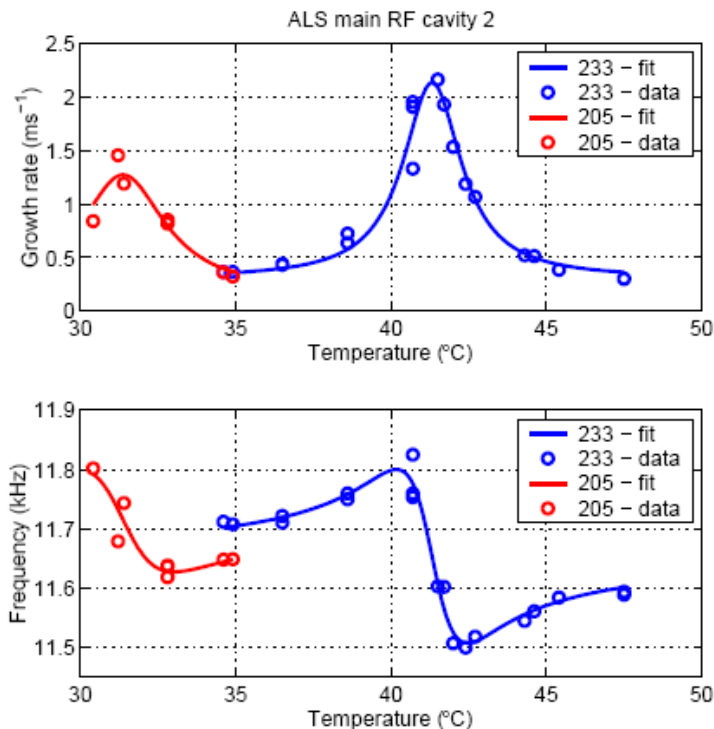

Figure 1: Growth rates (top) and oscillation frequencies (bottom) of modes 205 and 233 in main RF cavity 2 normalized to 100 mA.

- When the temperature of a cavity is changed, the tuner/matcher loops keep the fundamental frequency constant. However, HOMO frequencies will change.
- HOMs will be swept over revolution harmonics, allowing to measure their worst case effect (i.e. quantify their coupling to the beam).

Other Diagnostics

- Diagnostics on the cavities:
 - Correlate beam measurements with signals from pickups on the cavities
 - If probes are at the right locations, one can see the excited HOMs directly.
 - Also can look at power deposited in loads of HOM dampers
- Any type of very fast (i.e. bunch-by-bunch or at least a few bunches) beamsizes/beam position measurement
 - Streak camera
 - Gated CCD camera on synchrotron light port
 - Photodiodes
 - Sampling scope on BPM button signals
- Diagnostics without Beam:
 - Measure Q, R/Q of cavity HOMs on a bench before installing them
 - Calculated precise HOM spectrum with finite element code.

Countermeasures: HOM dampers

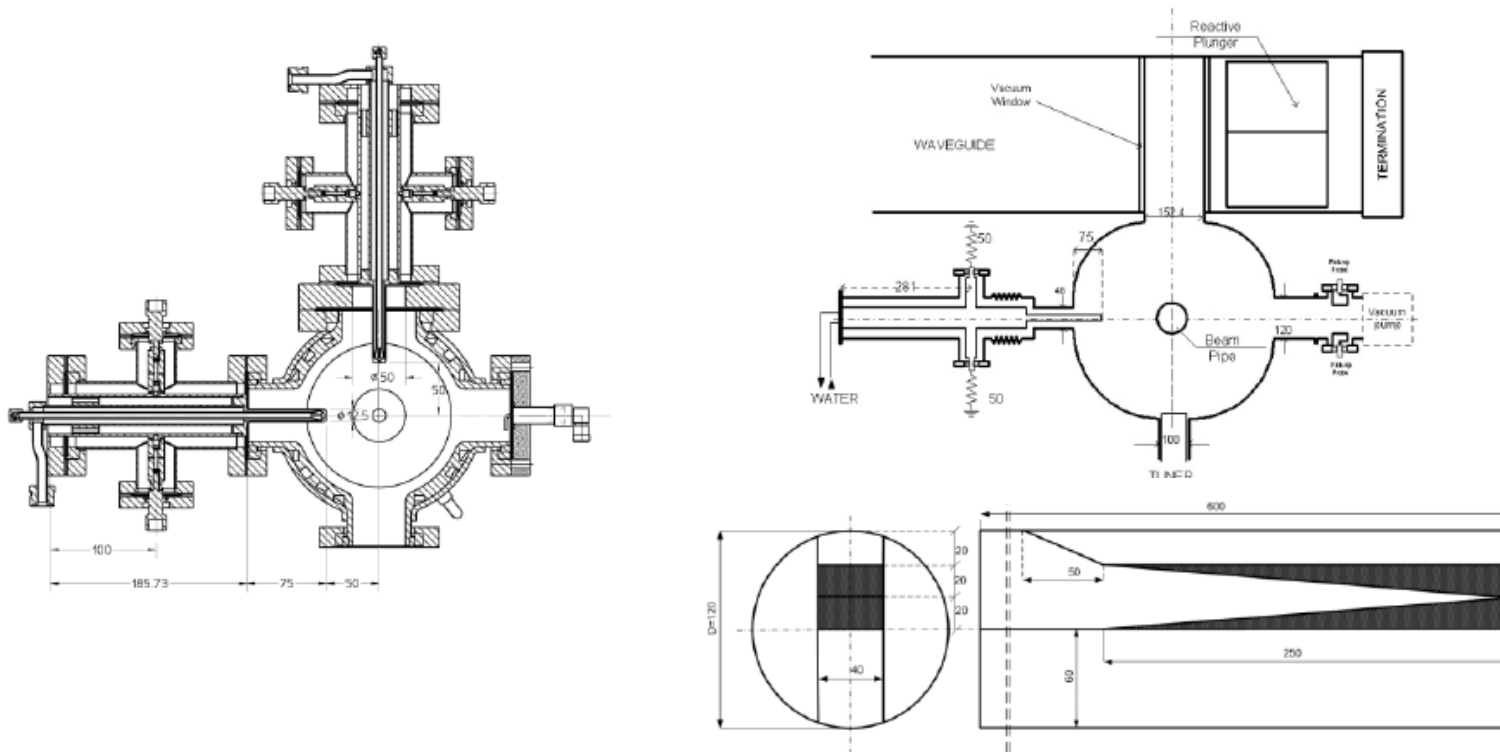

- Once one has understood, which higher order modes are the most damaging, one can design dampers to specifically target those modes.
- Newer developments (both on n/c and s/c cavities) are broadband, waveguide type dampers, which damp many modes at once.

Two Stream Instabilities

- In these cases, charged ‘clouds’ (second stream) of particles is the wakefield mechanism driving the instability
- Potential mechanisms for two-stream instabilities are:
 - Ion-trapping
 - Slow ion instability
 - Fast ion instability
 - Secondary electron / Multipacting
 - Electron cloud instability

Slow Ion Trapping

- High energy beam particles ionize residual gas
- (Mostly positive) ions can be trapped in potential of negatively charged beam
- Depending on charge and beamsize, transverse ion oscillation frequencies can be of the order of MHz and motion can be quite stable
 - Periodic focusing due to bunch passage

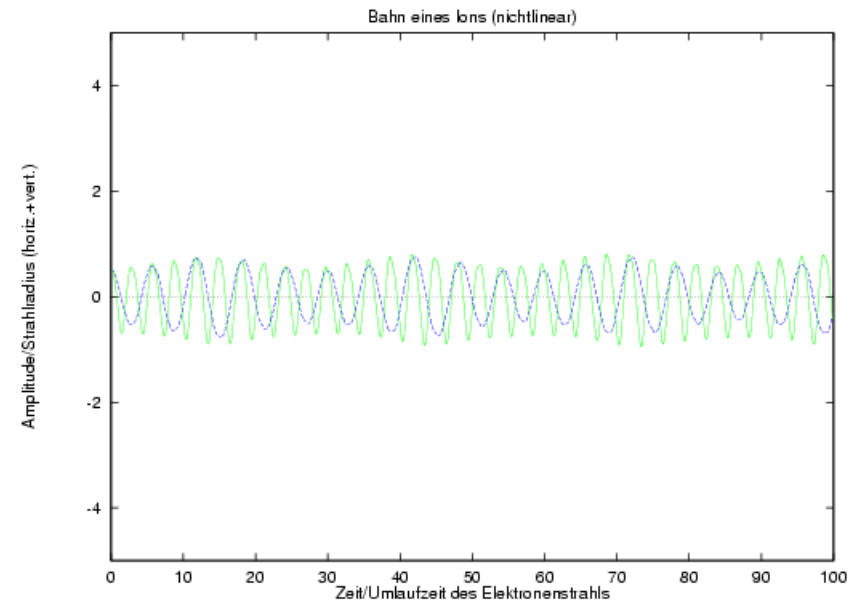
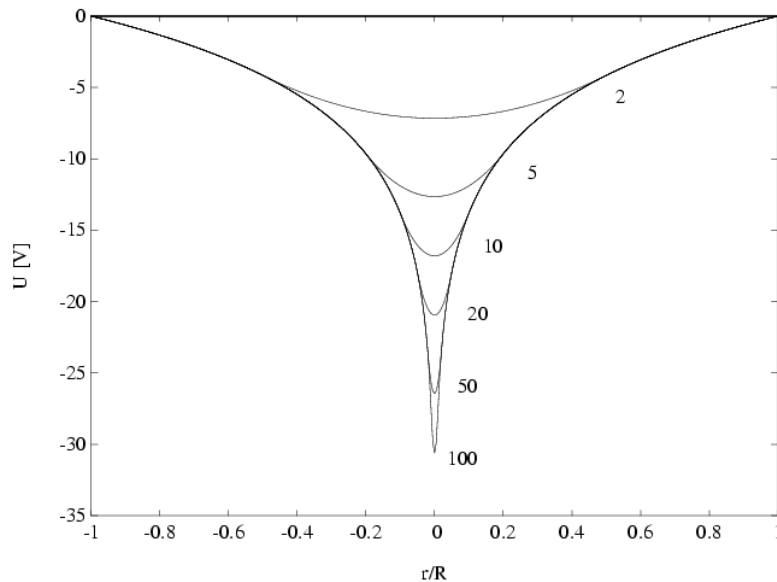

Slow Ion Trapping II

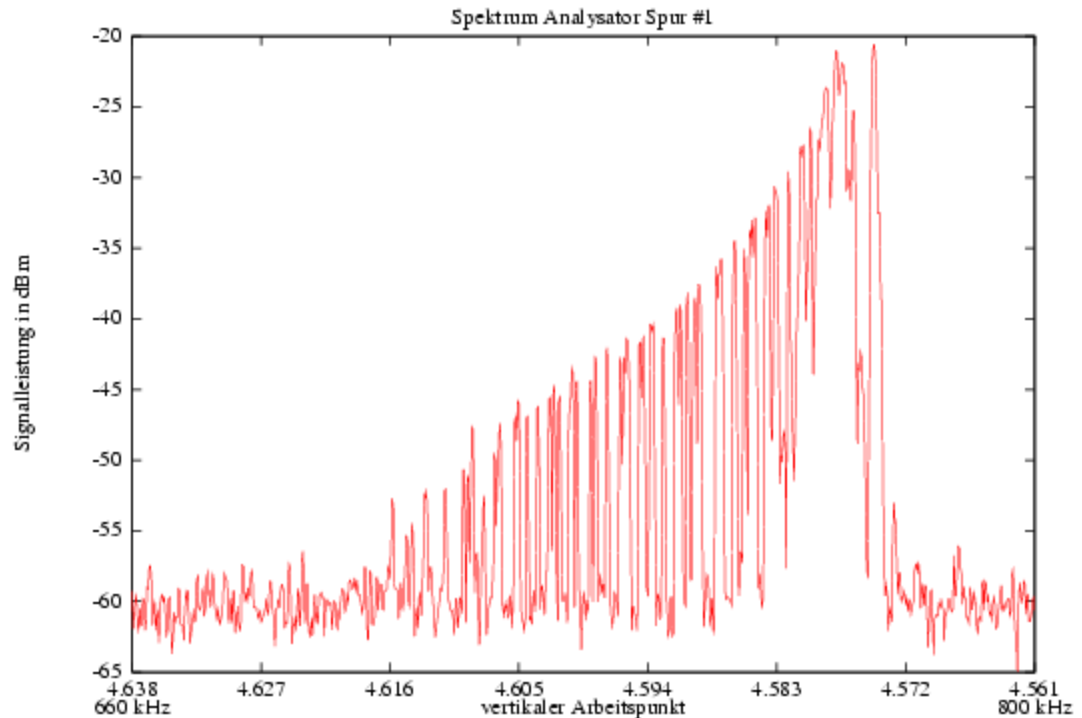
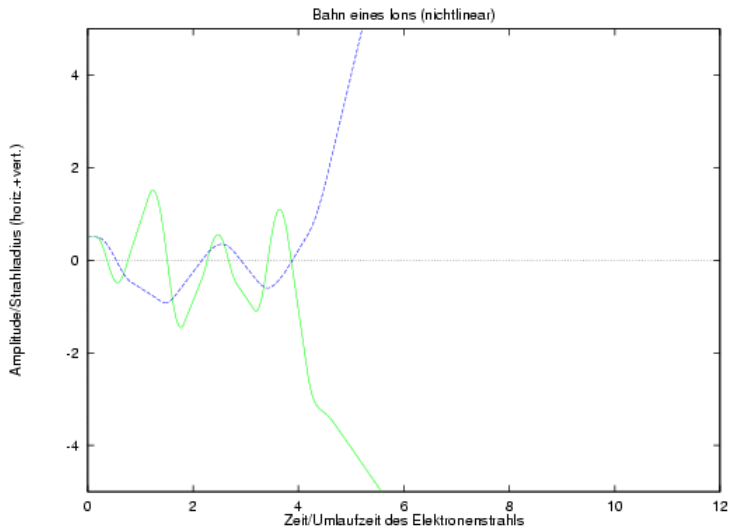

- Trapped ions can have many deleterious effects:
 - Scattering – Lifetime
 - Tune Shift
 - Instabilities (they act as an effective wakefield coupling the motion of different bunches)

Diagnostics for Ion Induced Instabilities

- Mode pattern of the instability:
 - Typically several neighbouring modes will become unstable at once
 - Mode frequency depends on beam current, vertical beamsize, ...
- Instability disappears for long gap in the fill pattern.
- Instability depends on residual gas pressure.
- Increase in Bremsstrahlung (off the trapped ions).
- Clearing electrodes (negative bias of order of 1 kV) improve instability – current drawn by electrodes correlate with other instability observations (fill pattern ...)
- Shaking of the beam might help.

Fast Ion Instability

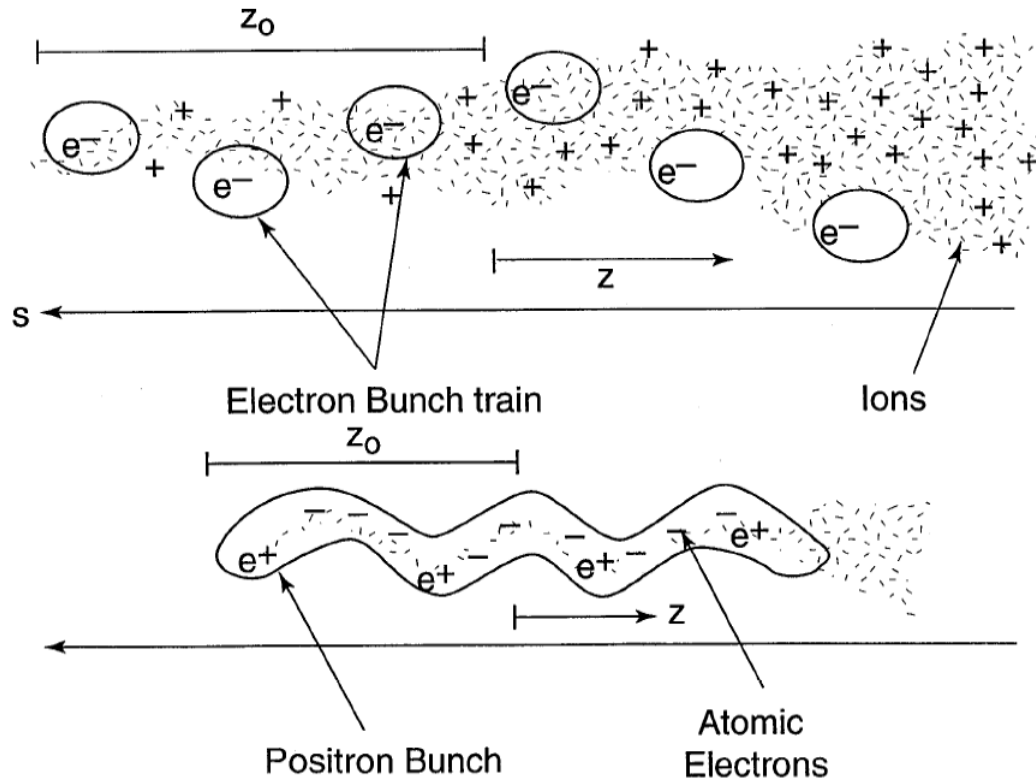

- If the electron current becomes very large, enough ions can be accumulated even single pass to lead to significant size increase for small emittance beams

ALS Fast Ion Instability – Example at ALS

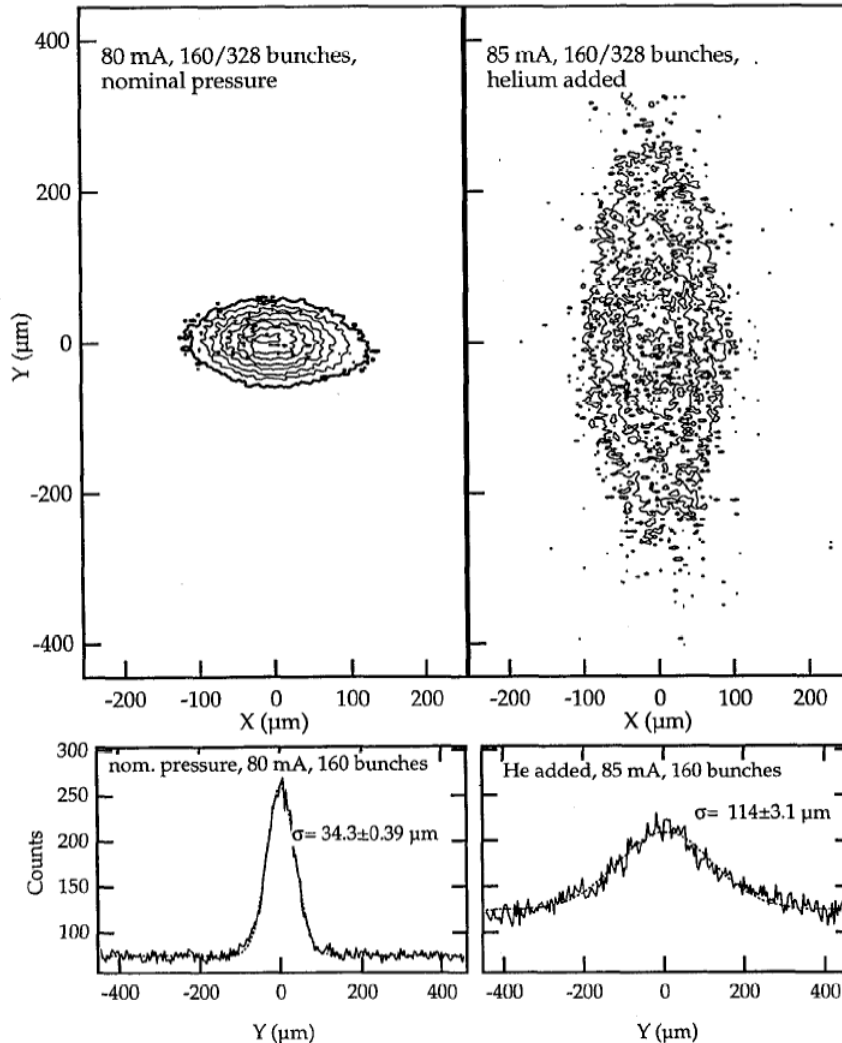

- Observe increase in projected vertical beam size
 - when He is added, single bunch beam size was increased by about 20%

Streak Camera image of fast ion instability

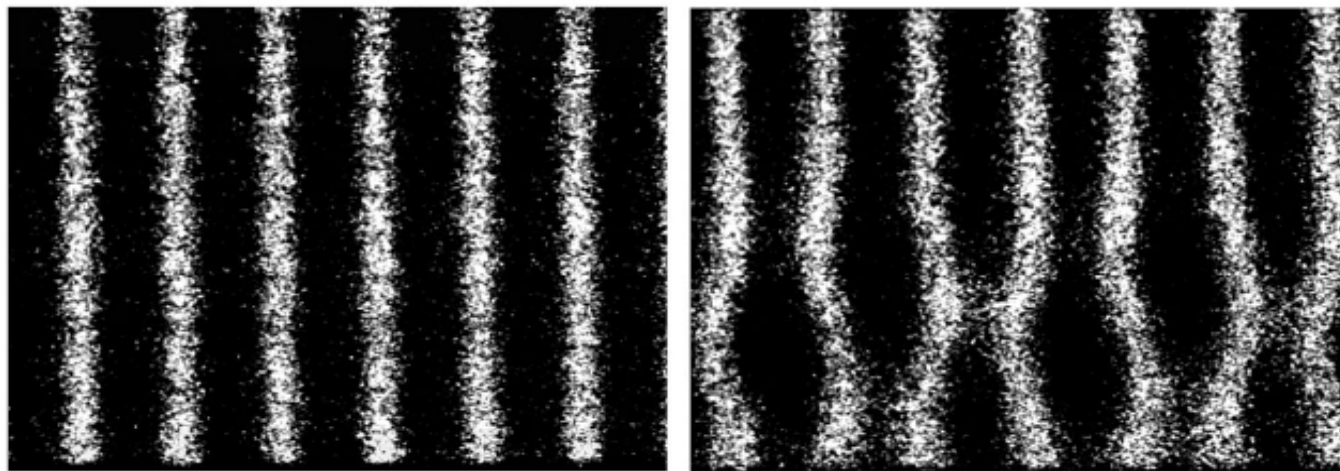

- Streak camera images of fast ion instability in PLS
- Vacuum pumps were switched off intentionally
- Clearly shows that head of bunch train stays stable whereas tail starts to oscillate
- No problem for nominal vacuum pressure

Similar streak camera image of fast ion instability at APS

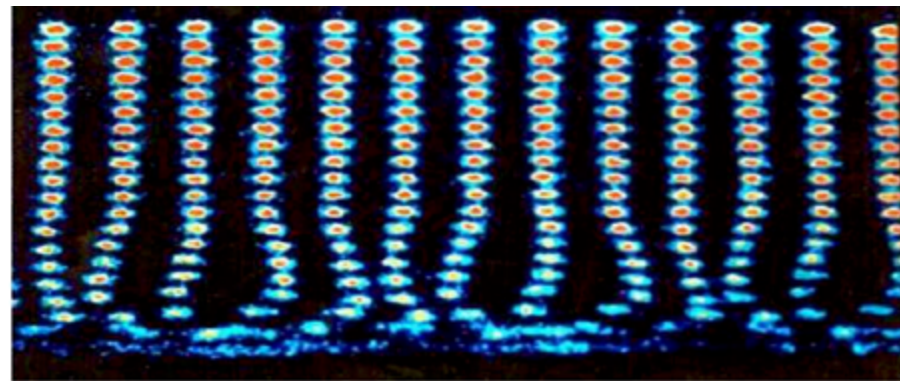

Electron Cloud Instability

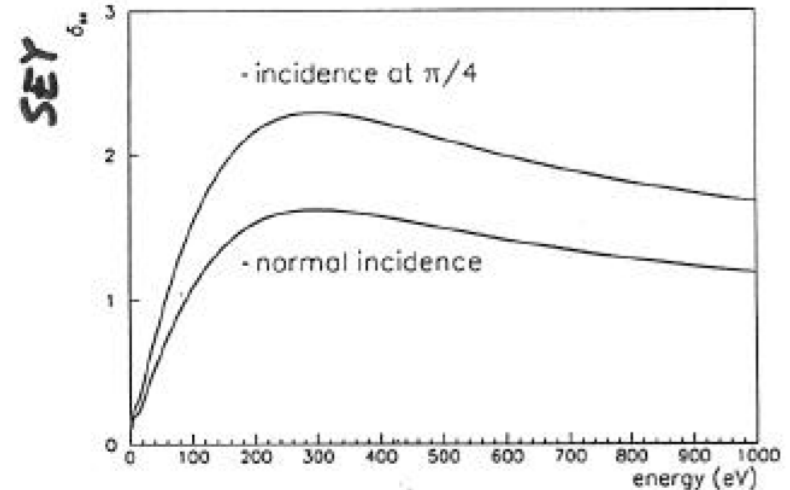
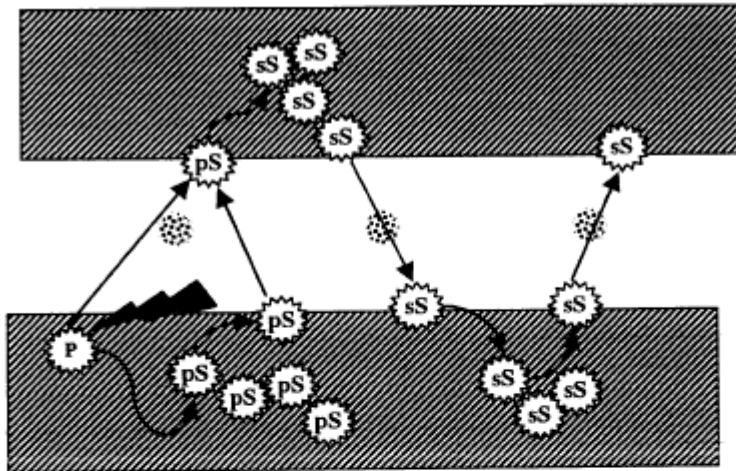

- Synchrotron radiation striking vacuum chamber produces initial electrons
- Get accelerated (transversely) by bunch passage
- With $SEY > 1$ multiplication can occur
- (Large number of) electrons then can interact with positron/proton beam and drive instability

Practical aspects of electron cloud

- Indications:
 - Emittance increase at high currents
 - Heat load on vacuum chamber walls
 - Erroneous vacuum pressure readings
- Diagnostics:
 - Retarding field analyzers, vacuum diagnostics, standard beam diagnostics (streak camera, BPMs, pickups, ...)
- Countermeasures:
 - Surface treatment to reduce secondary electron yield
 - Wait for surface scrubbing to occur
 - Magnetic fields (solenoidal fields are particularly effective)
 - Gaps in bunch train

Summary

- Concepts introduced today:
 - Collective Effects
 - Wake Fields
 - Impedance
 - Single/Multibunch Instabilities
 - Feedbacks
 - Two Stream Instabilities
 - Characterization of instabilities and impedances contains many different beam based techniques

Thanks to Fernando Sannibale for several illustrations

Further Reading

- L. Palumbo, V. G. Vaccaro, M. Zobov, “Wake fields and impedances”, CERN-95-06
- A. Chao, “Physics of Collective Beam Instabilities in High Energy Accelerators”, Wiley-Interscience Pub. (1993).
- A. Chao, M. Tigner, “Handbook of Accelerator Physics and Engineering”, Word Scientific Pub. (1998).
- S. Myers “Instabilities and Beam Intensity Limitations in Circular Accelerators”, CERN

Backup Slides

Space Charge Force

- Next week we will talk about how Coulomb scattering can generate particle losses by the Touschek Effect.
- The Coulomb interaction is also responsible for the space charge effect. In this case, a particle in a bunch experiences the *collective* Coulomb force due to all other particles in the bunch.
- Such fields, referred to as *self-fields*, are quite nonlinear and their evaluation usually requires numerical techniques.
- However, by using some approximations, it is possible to obtain analytical solutions that allow some studies of the effects.
- For a Gaussian distribution the fields inside the beam are:

$$E_x = \frac{1}{2\pi\epsilon_0} \frac{\lambda}{\sigma_x(\sigma_x + \sigma_y)} x, \quad E_y = \frac{1}{2\pi\epsilon_0} \frac{\lambda}{\sigma_y(\sigma_x + \sigma_y)} y, \quad B_x = -\frac{\mu_0}{2\pi} \frac{\lambda\beta c}{\sigma_y(\sigma_x + \sigma_y)} y, \quad B_y = \frac{\mu_0}{2\pi} \frac{\lambda\beta c}{\sigma_x(\sigma_x + \sigma_y)} x$$

- The fields scale linearly with x and y and there is the following relation between E and B:

$$B_x = -\frac{\beta}{c} E_y, \quad B_y = \frac{\beta}{c} E_x,$$

Space Charge Effects

$$\vec{F} = q(\vec{E} + \vec{v} \times \vec{B})$$

And using the
previous relations:

$$F_x = q(E_x - \beta c B_y) = qE_x(1 - \beta^2) \propto \lambda(1 - \beta^2)_x$$

$$F_y = q(E_y + \beta c B_x) = qE_y(1 - \beta^2) \propto \lambda(1 - \beta^2)_y$$

- Space charge forces become negligible for relativistic beams.
- In addition, the forces are repulsive and proportional to the distance from the beam center. This is equivalent to a defocusing quadrupole in both planes (strength proportional to beam current).
 - Current dependent betatron tune shift for particles in the core of the beam.
- For tail particles the force becomes nonlinear and numerical calculations are required for the evaluation of the space charge effects.

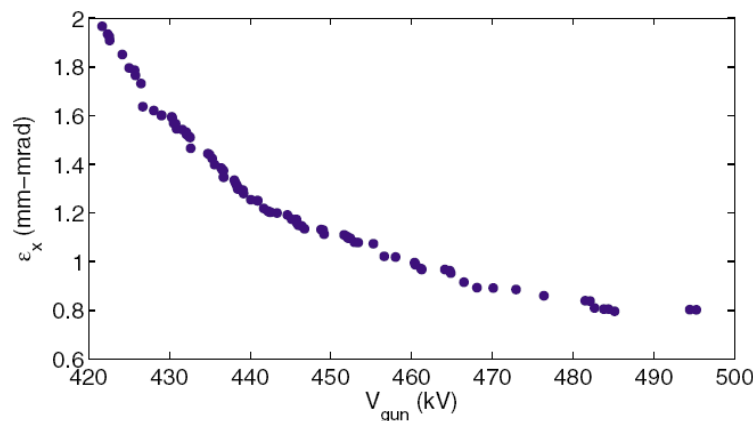

Wake Fields

- The beam and its electromagnetic field travel inside the vacuum chamber while the image charge travels on the chamber itself.
- Any variation of the chamber profile or the material properties breaks the continuity.
- The result is that the beam loses a (usually small) part of its energy that feeds the electromagnetic fields that remain after the passage of the beam. Such fields are referred to as wake fields.

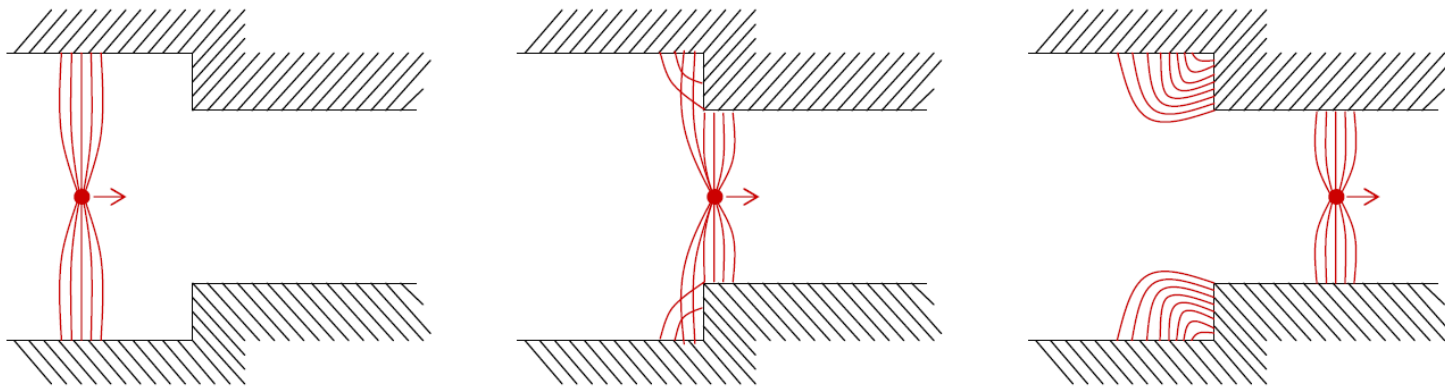

- Vacuum chamber wake fields generated by beam particles mainly affect trailing particles and in the case of ultra-relativistic beams can only affect trailing particles.

Wake Potentials + Functions

- There are longitudinal and transverse wake fields. Longitudinal wakes affect the particle energy, while transverse wake affect the transverse momentum. For longitudinal wake fields we consider *only the electric component of the wake fields*.
- It is often convenient to deal with wake potentials instead of wake fields. The wake potential is defined as the energy variation induced by the wake field of the leading particle on a unit charge trailing particle.

$$V_W(\vec{r}_{lead}, \vec{r}_{trail}, t_{trail} - t_{lead}) = \int_{-\infty}^{\infty} \vec{E}_W(s, \vec{r}_{lead}, \vec{r}_{trail}, t_{trail} - t_{lead}) \cdot d\vec{s},$$

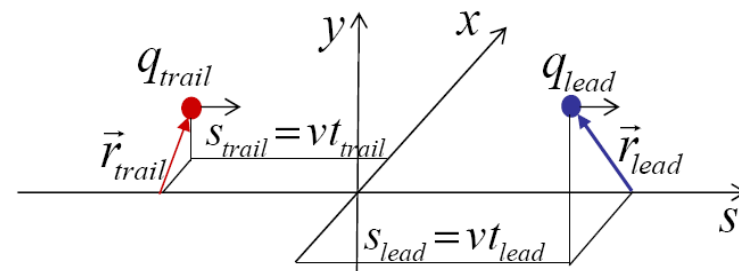

- The wake function is instead defined as the energy variation induced by the wake field of a unit charge leading particle on the unit charge trailing particle.

$$W(\vec{r}_{lead}, \vec{r}_{trail}, t_{trail} - t_{lead}) = \frac{V_W(\vec{r}_{lead}, \vec{r}_{trail}, t_{trail} - t_{lead})}{q_{lead}}$$

- The *total wake potential* for a bunch with charge distribution i with:

$$\int i(\vec{r}, t) d\vec{r} dt = Nq$$

- is given by:

$$V(\vec{r}_{trail}, t_{trail}) = \int W(\vec{r}, \vec{r}_{trail}, t_{trail} - t) i(\vec{r}, t) d\vec{r} dt$$

- Total wake potential = energy variation that trailing particles experience due to the wakes of the whole bunch.

Vacuum Chamber Cutoff

- In real accelerators the vacuum chamber has a very complex shape and includes many components that can potentially have “trapped” HOMs.
- Not all the wakes excited by the beam can be trapped in the vacuum chamber. For a given vacuum chamber geometry there is a cutoff frequency such that modes with frequencies above cutoff propagates along the chamber:

$$f_{\text{Cutoff}} \approx \frac{c}{a} \quad a \equiv \text{chamber transverse size}$$

- In summary, when the beam transits along the vacuum chamber it excites wake fields. These can be classified in three main categories:
 - wake fields that travels with the beam (such as the space charge);
 - wake fields that are localized in some resonant structure in the vacuum chamber (narrow and broad band HOM);
 - high frequency wakes, above the vacuum chamber cutoff, that propagate along the vacuum chamber. This last category does not generate any net interaction with the beam unless they are synchronous with the beam itself.

Instabilities: Equations of motion

- Harmonic oscillator with driving term $\ddot{u} + \omega_0^2 u = Gu = (G_R + jG_I)u$

- Solution: $G \propto jI_0 \frac{\sum Z(\omega)h(\omega)}{\sum h(\omega)}$

$$u = u_0 \exp(j\omega_n t)$$

$$\omega_n = \omega_0 + \Delta\omega, \text{ and } \Delta\omega = -\frac{G}{2\omega_0} = -\frac{G_R}{2\omega_0} - j\frac{G_I}{2\omega_0}$$

$$u = u_0 \exp(j\omega_0 t) \cdot \exp\left(-\frac{jG_R}{2\omega_0} t\right) \cdot \exp\left(+\frac{G_I}{2\omega_0} t\right).$$

- Growth/Damping coefficient $\alpha = \frac{1}{\tau} = -\text{Im}(\Delta\omega) = +\frac{G_I}{2\omega_0}$

Potential Well Distortion

- The potential well distortion mechanism is very general and common to all kind of wakes in rings. Remembering that wakes can be represented by the real and imaginary part of the impedance, some common “rules” can be derived.
- The real (resistive) part of the coupling impedance generates *asymmetric distortions* and *lengthening* of the bunch distribution. The *bunch center of mass moves towards a different RF phase* to compensate for the wake induced energy losses.
- The imaginary (reactive) part of the coupling impedance generates *symmetric distortions* of the bunch distribution. The *bunch center of mass does not move* (no energy losses). It generates *bunch lengthening or shortening*.

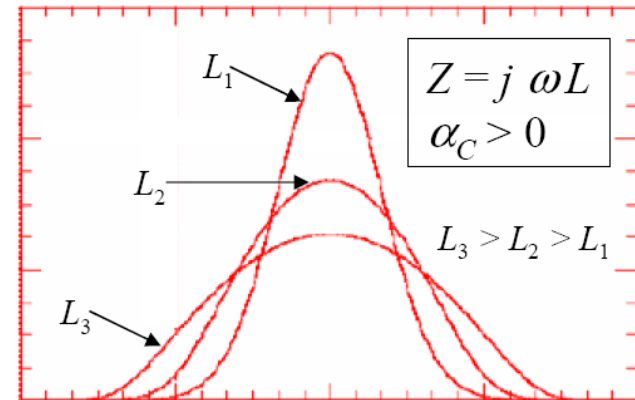
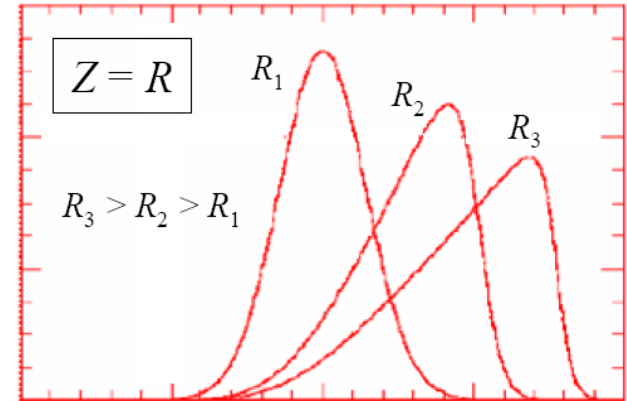

Robinson Instability

- So called Robinson instability is fundamental single bunch instability. Cure is very simple, but is fundamentally very similar to the very common multi bunch instabilities.

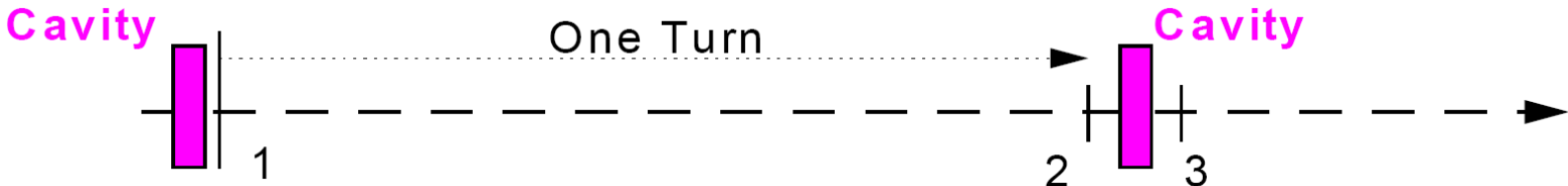
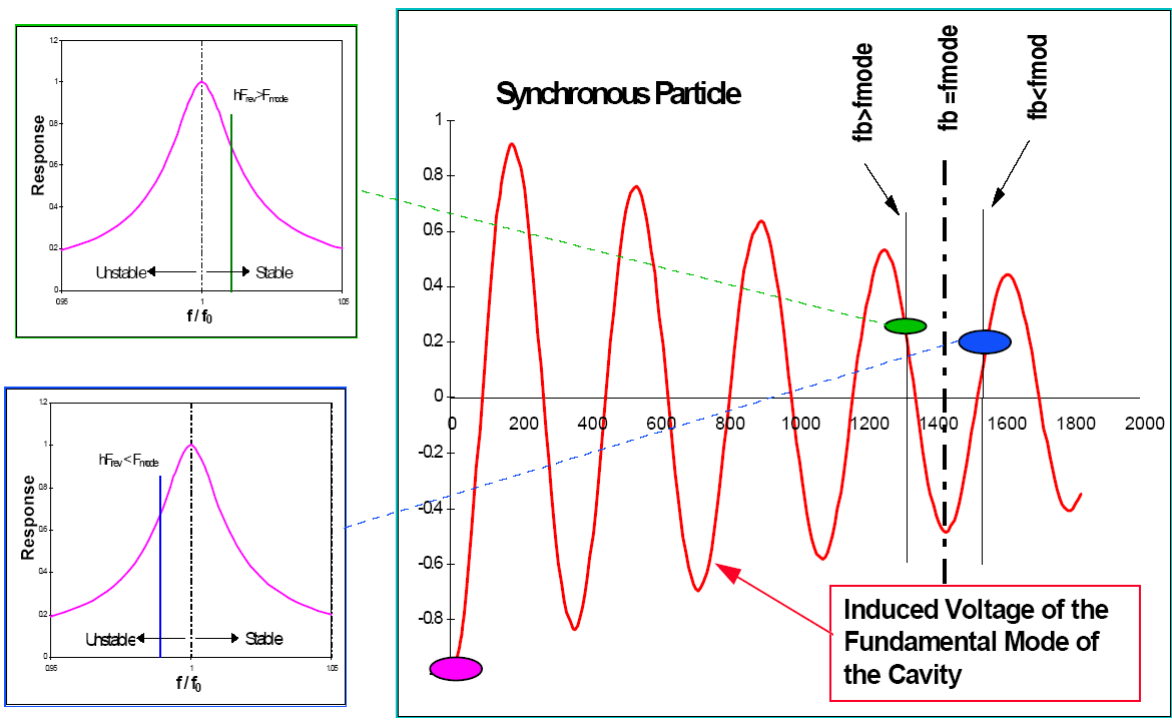

ALS Dipole, Quadrupole, ... Oscillations

- There are different shapes of oscillations:
 - Dipole – ‘rigid body’
 - Quadrupole – shape/size
 - Sextupole ...

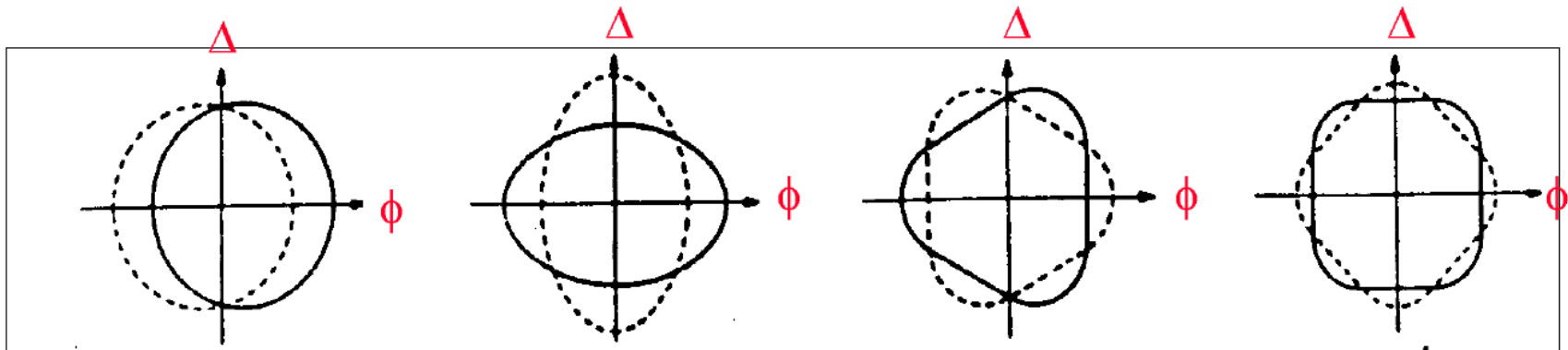

$m = 1$
dipole mode

$m = 2$
quadrupole mode

$m = 3$
sextupole mode

$m = 4$
octupole mode

Multiple DOF Systems

$N = 1$



$N = 2$



$N = 3$

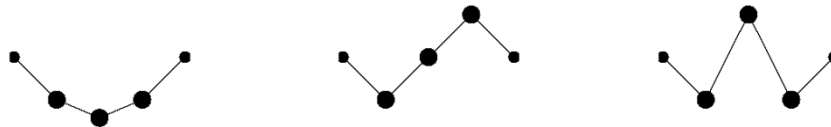

$N = 4$

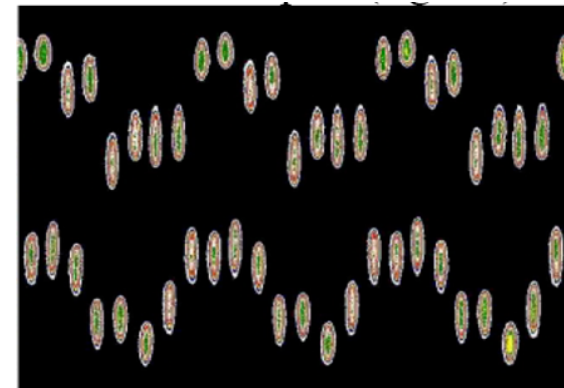
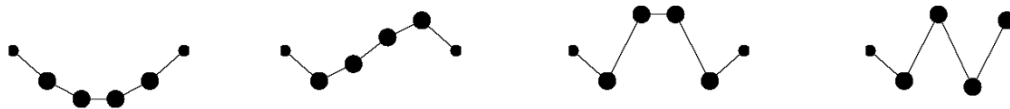

Streak camera
image of HOM
driven,
longitudinal
multibunch
instability at
ESRF

From Dan Russel's Multi DOF Systems

Description of Multibunch Instabilities

- By using the model of coupled harmonic oscillators, every mode can be characterized by a complex frequency ω and by the equation of a damped oscillator:

$$\varphi_n(t) = \hat{\varphi}_n e^{-(\text{Im}[\omega_n] + \alpha_D)t} \sin(\text{Re}[\omega_n]t + \varphi_{n0}) \quad \alpha_D \equiv \text{radiation damping}$$

- The oscillation becomes unstable (anti-damping) when:

$$\text{Im}[\omega] + \alpha_D < 0 \quad (\alpha_D > 0 \text{ always})$$

- Wakes fields produce a shift of the imaginary part of the frequency:

$$\Delta \text{Im}[\omega_n] \approx I_B \frac{e\alpha_C}{v_s E} Z(\omega_n)$$

- Depending on the signs of the momentum compaction and of the impedance, some modes can become unstable when the current per bunch is increased.
- Feedback systems increase α_D so that to increase the threshold for the instabilities.